



Thunder Bay Fire Rescue

Recreational Burning Permit

Guidelines for Chimineas, Outdoor Fireplaces and Fire Pits

1. No unapproved burning will take place as per the Ontario Fire Code. Burning will only be permitted after an appropriate permit is acquired.
2. A \$30.00 fee will be collected for a New Fire Permit which includes the inspection fee. Yearly Fire Permit renewals will be \$30.00 thereafter.
3. Burning will take place between 1700 and 2400 hours (5:00 p.m. and 12:00 a.m.).
4. Burning will be allowed only if approved and the site has been inspected by an Officer of the Thunder Bay Fire Rescue prior to issue of permit.
5. Permits are issued on an annual basis and must be renewed each year. 2 year burn permits are available on-line. A fire ban will suspend all permits.
6. Only small pieces of clean dry wood or charcoal are to be used.
7. Permit cancellation may occur as a result of applicant not following the rules and regulations.
8. No burning shall take place within 2 metres of any wooden structure, combustibles or property line and 5 metres if a residential building is adjacent to fire pit.
9. Fire pits and appliances must be isolated and surrounded by a noncombustible material. Pea gravel or coarse sand should be used on the bottom of the pit to assure protection below and to discourage smoldering material.
10. If an appliance such as a chiminea is to be used on a wooden deck, proper shielding to protect the combustible deck will be required, as outlined in section 2.6.2. of the Ontario Fire Code.
 - 8” clearance on all sides
 - 18” clearance on loading side
 - For heat protection, one course of brick, or stone to be installed under appliance.
 - For ember protection, sheet metal to be installed under brick or stone.
11. An extinguishing device such as a garden hose or portable fire extinguisher must be available in case of emergency.
12. Approved burning appliance / pit shall not be relocated or altered in any way, shape or form without the approval and re-inspection by the Fire Service.

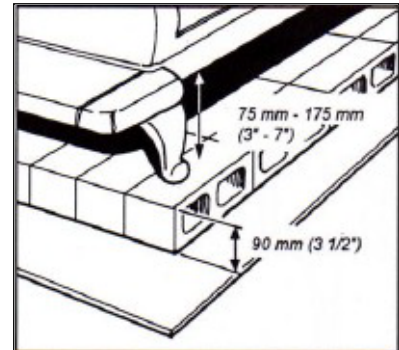

Burn Permit Applications are available on our website or any of the Fire Stations below.

Southward Fire Stations

Station 1	330 Vickers St N	625-2105
Station 4	501 Churchill Dr	577-8079
Station 6	1710 Frederica St W	473-5023
Station 7	2065 20th Side Rd	473-4990

Northward Fire Stations

Station 2	20 Junot Ave	768-0641
Station 3	60 Water St S	684-2916
Station 5	300 Hodder Ave	683-3541
Station 8	3000 Government Rd	768-0402

Apply online at www.thunderbay.ca/fire